

Temperature Gauges / Bi-Metal Thermometers / Industrial Bi-Metal Thermometers / Ø 100 mm. - Adjustable

CONSTRUCTIVE PROPERTIES

	STANDARD	OPTIONAL
Mounting Type	Bottom Connection Adjustable head	-
Scale Unit	°C	°F
Scale Range (T)	-30/+60°C 0/+60°C 0/+100°C 0/+120°C 0/+160°C 0/+300°C 0/+350°C 0/+400°C 0/+500°C	
Case	Stainless Steel AISI-304	Stainless Steel AISI-316L
Bezel	Stainless Steel AISI-304	Stainless Steel AISI-316L
Window	Glass	Safety Glass
Connection	G 1/2" B	1/2" NPT
Dial	Aluminum	-
Pointer	Aluminum	-
Filling Liquid	-	Silicon Oil (≤ +300°C)
Bi-Metal Stem	Stainless Steel AISI-316	-
Temperature Element	Bi-metal	-
Stem Ø	9 mm	6mm 8mm
Thermowell	Stainless Steel AISI-316	-
Immersion Length	100mm 150mm 200mm 700mm 1000mm 250mm 300mm 400mm 500mm	



TB100ZS6

USAGE PROPERTIES

Accuracy Class	CL 2.0	CL 1.0
Protection Rate	IP 51	IP 65
Storage Temperature	-40 ... +70 °C	-
Conformity	EN 13190	ATEX 94/9/EC
Max.Pressure	25 bar	-

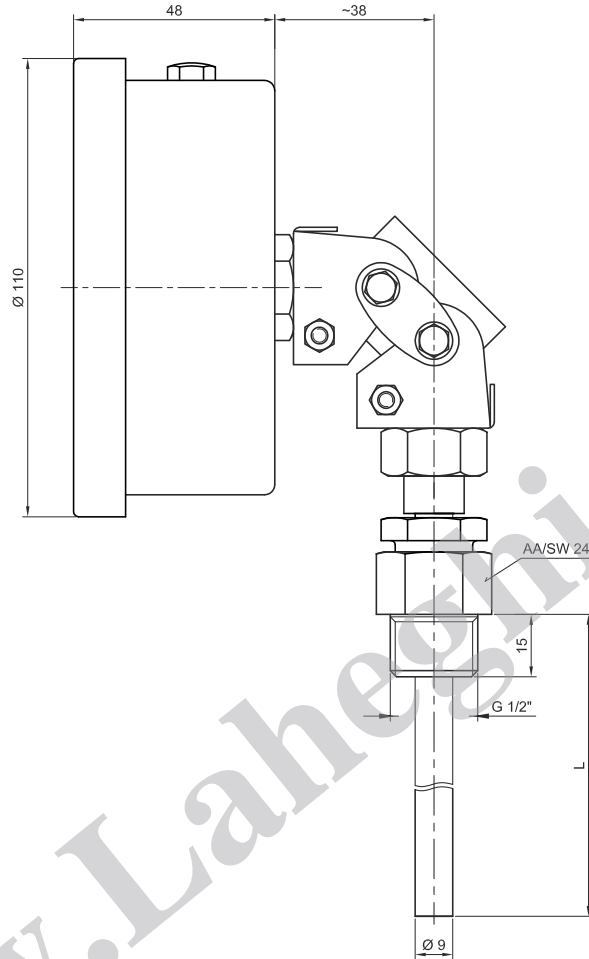

- | | | | | | | | | |
|---------|---------|---------|---------|---------|---------|---------|---------|----------|
| L = 100 | L = 150 | L = 200 | L = 250 | L = 300 | L = 400 | L = 500 | L = 700 | L = 1000 |
|---------|---------|---------|---------|---------|---------|---------|---------|----------|